

INSTRUÇÕES DE MONTAGEM
PRATELEIRA COM COSTA LISA

LONDRES

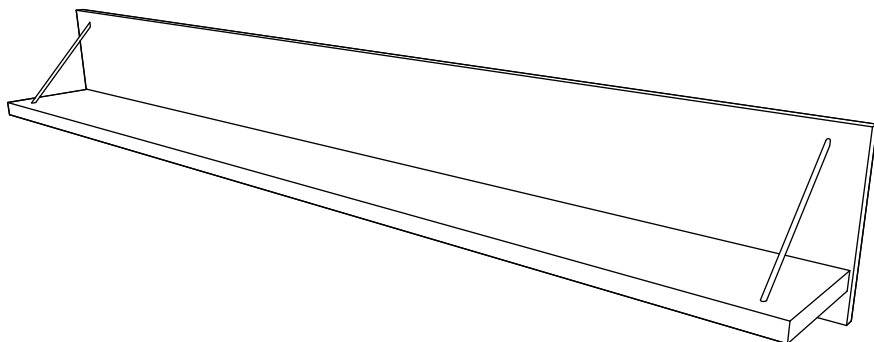

ANTARTE

design for life

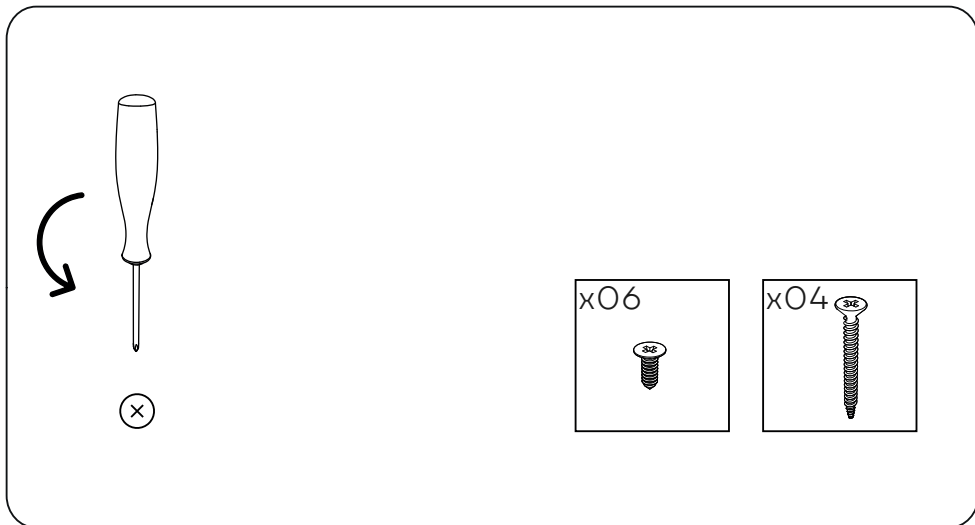

Obrigado pela sua preferência!

O design, a elegância e o conforto
estão agora mais perto de si!

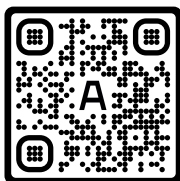

01

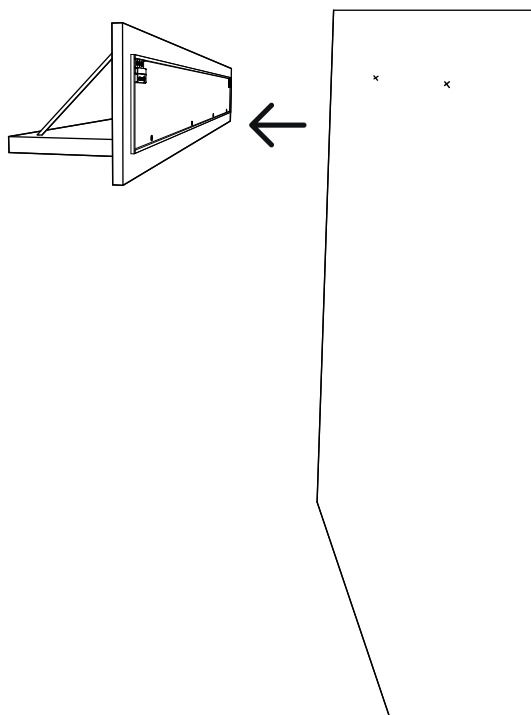
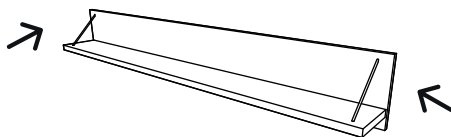
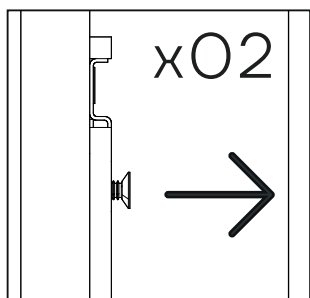

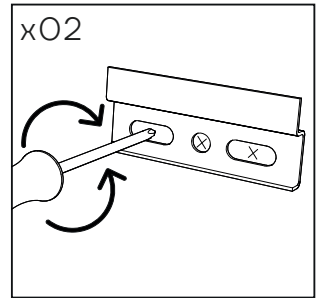
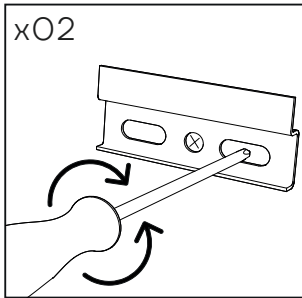
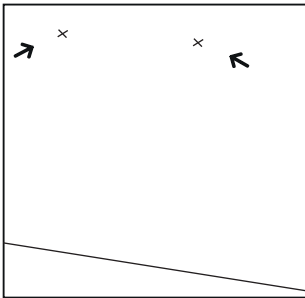
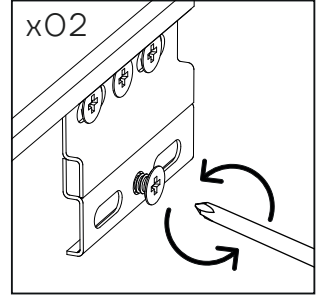
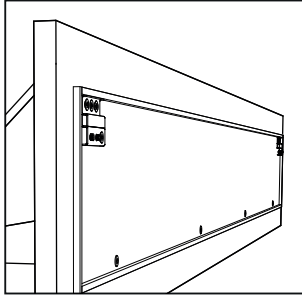

03

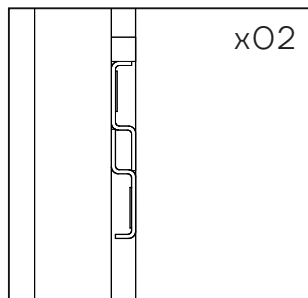
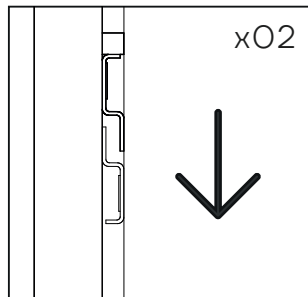
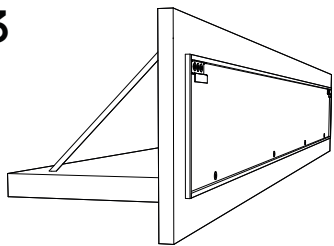



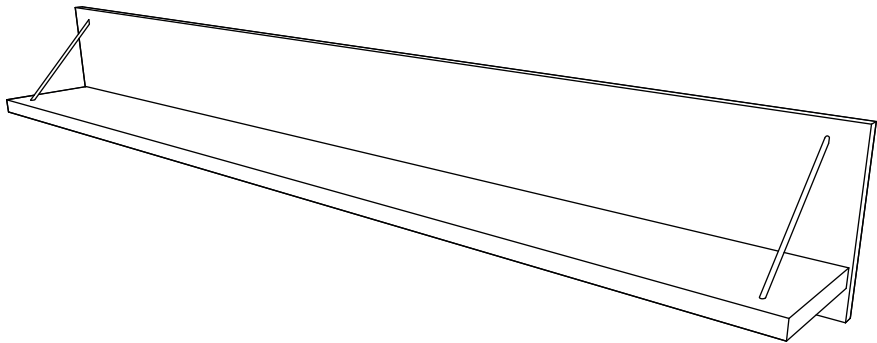



ANTARTE

design for life

SEDE:

AV. DA ZONA INDUSTRIAL, 222
4585-303 REBORDOSA

PAREDES, PORTUGAL

+351 224 119 350

(chamada para a rede fixa nacional)

ANTARTE@ANTARTE.PT

WWW.ANTARTE.PT